

Powered By 

Quickset User Manual

V2.06 Build0115



Tel: 510 490 3888

Fax: 510 490 3887

<http://www.newlandna.com>

Contents

CHAPTER 1	INTRODUCTION.....	1
CHAPTER 2	USER INTERFACE.....	1
2.1	Guide to Menu.....	2
2.1.1	File	2
2.1.1.1	COM Setup.....	2
2.1.2	View	3
2.1.3	Option.....	3
2.1.3.1	Receive Data	4
2.1.3.2	Update Firmware.....	5
2.1.4	Window	5
2.1.5	Help.....	6
2.2	Guide to Toolbar	7
2.3	Guide to Command Window and its Functions	8
2.3.1	Buttons of Command	8
2.3.1.1	Parameter Setup	9
2.3.1.2	Parameter Query.....	17
2.3.2	Command Display Window	20
2.4	Guide to Bitmap Window	20
CHAPTER 3	DETAILED COMMAND REFERENCE.....	21
3.1	Handshake Command.....	21
3.2	Setup Command	21
3.2.1	'00': communication parameter setup.....	21
3.2.2	'01': Reserved (CMOS parameter quondam)	21
3.2.3	'02': Light and aiming setup	21
3.2.4	'03': 1D barcode setup	22
3.2.5	'04': 2D barcode reading setup	22
3.2.6	'05': Code reading overall setup	22
3.2.7	'06': Macro mode setup	22
3.2.8	'07': Initialized.....	23
3.2.9	'08': 2D barcode reading combined setup(enable/disable)	23
3.2.10	'09': 1D barcode reading combined setup (enable/disable)	23
3.2.11	'10': Barcode length setup	23
3.2.12	'11': 1D barcode parameters setup.....	24
3.2.13	'12': Decoding mode setup	25
3.2.14	'13': System overall setup.....	25
3.2.15	'14': reserved	26
3.2.16	'15': data format setup except prefix/suffix	26
3.2.17	'16': OCR enable/disable setup.....	26
3.2.18	'17': Reserved	26
3.2.19	'18'-'25': Reserved	26
3.2.20	'26': Repeat rading and delay reading setup	26
3.2.21	'27': self-prefix/ self-suffix setup.....	27

3.2.22	'28': prefix/suffix setup.....	28
3.2.23	'29'-'99': reserved	29
3.3	Setup Return	29
3.4	Inquir Command.....	29
3.4.1	0x30、0x31—to inquire parameter of communication.....	29
3.4.2	0x32—to inquire 1D bar code permit or prohibit.....	29
3.4.3	0x33—to inquire 2D bar code permit or prohibit.....	29
3.4.4	0x34—reserved (to inquire preferential reading parameter)	29
3.4.5	0x35—to inquire light/aiming setup parameter;.....	29
3.4.6	0x36—to inquire macro setup	29
3.4.7	0x37—to inquire prefix/suffix.....	29
3.4.8	0x38—to inquire CodeID.....	29
3.4.9	0x39—to inquire AIM.....	29
3.4.10	0x40—to inquire terminator suffix.....	29
3.4.11	0x41—to inquire minimum length and maximum length	29
3.4.12	0x42—to inquire prefix/suffix order	29
3.4.13	0x43—to inquire 1D barcode parameter	29
3.4.14	0x44—to inquire decode mode	30
3.4.15	0x45—Reserved.....	30
3.4.16	0x46—to inquire the data format except prefix/suffix	30
3.4.17	0x47—to inquire version.....	30
3.4.18	0x48—to inquire overall infromation.....	30
3.4.19	0x49—to inquire OCR disable/enable	30
3.4.20	0x4A—to inquire user especial Parameter.....	30
3.4.21	0x4B~0xFF—Reserved.....	30
3.5	The return of inquire command	30
3.5.1	To inquire parameter of communication	31
3.5.2	To inquire 1D bar code disbale or enable.....	31
3.5.3	To inquire 1D bar code disbale or enable(reserved).....	31
3.5.4	To inquire light/aiming.....	31
3.5.5	To inquire macro setup.....	31
3.5.6	To inquire self-prefix/ self-suffix	31
3.5.7	To inquire CodeID.....	31
3.5.8	To inquire AIM.....	31
3.5.9	To inquire terminal suffix.....	31
3.5.10	To inquire minimum length and maximum length	31
3.5.11	To inquire Prefix order	32
3.5.12	To inquire 1D barcode Parameters	32
3.5.13	To inquire decoding mode.....	32
3.5.14	To inquire the data format except prefix/suffix	33
3.5.15	To inquire version.....	33
3.5.16	To inquire overall infromation	33
3.5.17	To inquire OCR disable/enable	34
3.5.18	To inquire user especial Parameter.....	34
3.6	Format of inquire return.....	34

3.6.1	Communication return formate	34
3.6.2	1D barcode Parameter	35
3.6.3	2D barcode Parameter	35
3.6.4	OCR Parameter	35
3.6.5	Light 、 aiming Parameter.....	36
CHAPTER 4	GUIDE TO OPERATIONS IN COMMON USE	37
1、	How to carry out equipment-detecting.....	37
2、	How to change baud rate of communication.....	37
3、	How to display decoded information	37
4、	How to upload images	37
5、	How to send commands with serial port.....	38

Chapter 1 Introduction

- Self-developed by Fujian Newland Auto-ID Tech. Co., Ltd., this software is designed to match 2D barcode reader, provided with the function of parameter configuration and data reading.
- Main Functions:
 - Test regular communications with device,
 - Configure various parameters of device,
 - Read various parameters of device,
 - Take images with the device.
- Features:
 - A friendly Users Interface,
 - Easily and quickly to scan any bar-coded item,
 - A version in English
 - Compatible with any barcode readers produced by Fujian Newland Auto-ID Tech. Co., Ltd.
 - Provided with detailed and various explanations of command to which a user can refer.

Chapter 2 User Interface

The basic user interface of the software is shown in Figure 1 below:

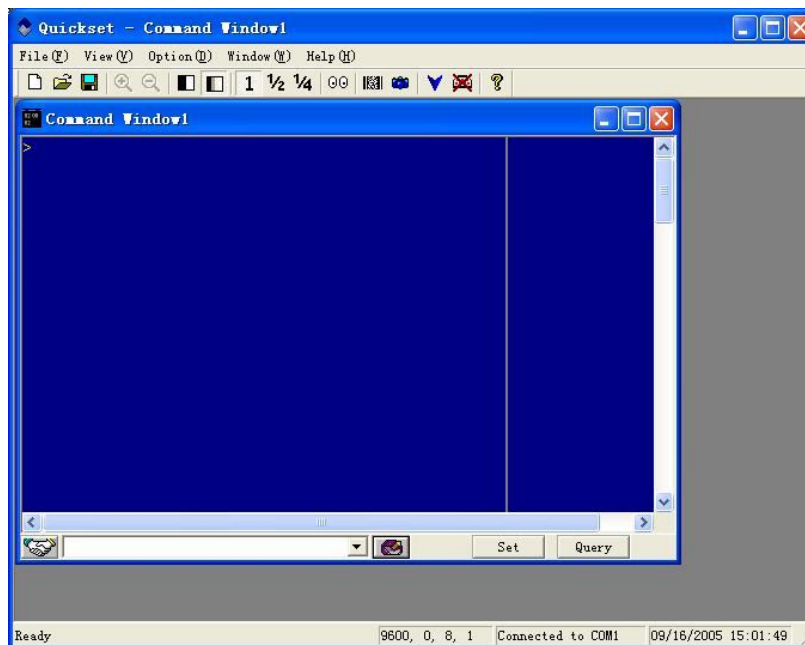

(Figure 1)

2.1 Guide to Menu

2.1.1 File

File			
File(F)	View(V)	Option(O)	Window(W)
New(N)	Ctrl+N		New
Open(O)...	Ctrl+O		Open
Close(C)			Close
Save(S)	Ctrl+S		Save
Print(P)...	Ctrl+P		Print
Print Preview(V)			Preview
Page Setup(R)...			Page Setup
PC COMM Setup(C)...			PC COM Setup
Image10.BMP			Exit
Exit(X)			

	Create a new command window
	Open a new command window or a 2D bitmap
	Close currently activated command window or bitmap window
	Save currently activated command window or bitmap window
	Print currently activated command window or bitmap window
	Abbreviated from Print Preview
	Page setup
	Set communication parameters of host computer (as shown in 2.1.1.1)
	Turn off the application program

(Figure 2)

2.1.1.1 COM Setup

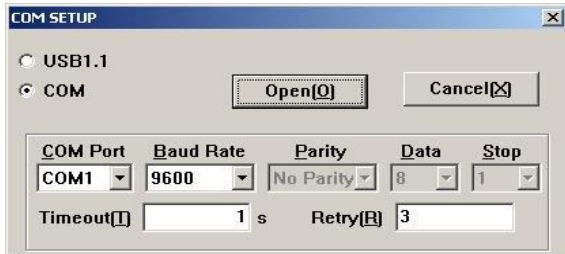
COM Setup		
		
(Figure 3)		
USB1.1		Mean to adopt the port of USB1.1 to communicate
COM		Mean to adopt the port of COM to communicate
Select COM for use	COM Port	Mean the port selected for use by host computer
	Baud Rate	Data transmitting speed (bps) of port selected for use
	Parity	The verification form (fixed)
	Data	The data bit of single frame message (fixed)
	Stop	The stop bit of single frame message (fixed)
	Timeout	Awaiting time (second) of receiving a single effective message
	Retry	Times of repeatedly sending for overtime message

2.1.2 View

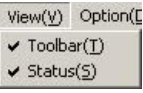
View		
 <p>(Figure 4)</p>	Toolbar	Toolbar used to hide or display
	Status	Status bar used to hide or display

2.1.3 Option

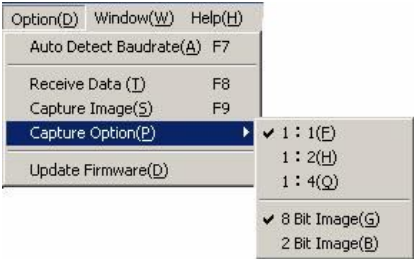
Option		
 <p>(Figure 5)</p>		
Auto Detect Baud rate		Detect device's Baud rate automatically and regulate the communication parameter of the host computer
Receive Data		Turn on real-time interception window and display 2D barcode decoded information (As shown in 2.1.3.1)
Capture Image		Take picture and send image data to the host computer
Capture Option	1: 1	Transmission of a whole image
	1: 2	Transmission of 1/2 image
	1: 4	Transmission of 1/4 image
	8 Bit Image	Transmission of gray-level image
	2 Bit Image	Transmission of binary image
Update Firmware		Download programs to the device (as shown in 2.1.3.2)

2.1.3.1 Receive Data

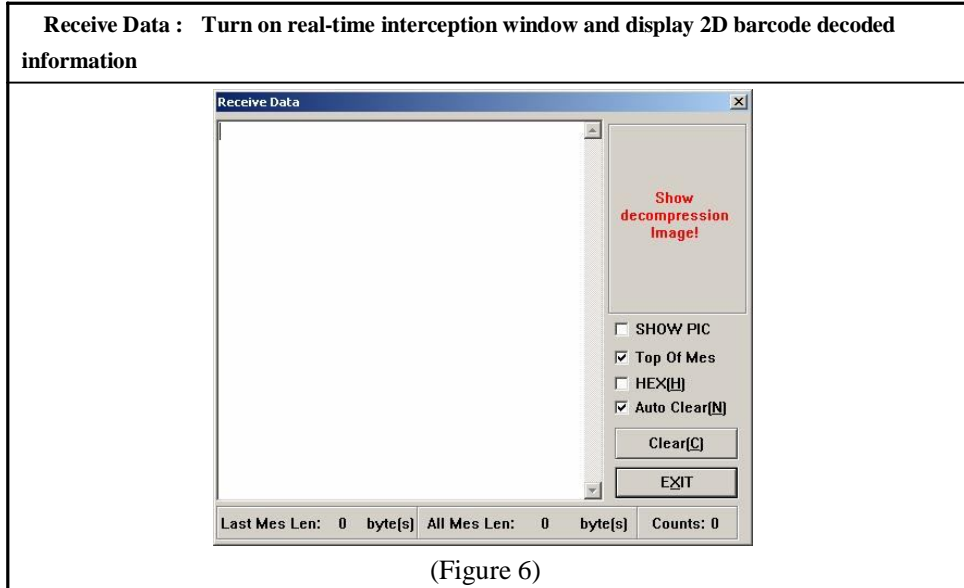

SHOW PIC	Display of image information included in the barcode with its format satisfied, which must adopt CodeMade or any image compressed program from Fujian Newland Auto-ID Tech. Co., Ltd., with a certain info-structure of its own.
Top of Mes:	Show the message got at present furthest front
HEX	Show the hex value one by one followed by the information's bytes
Auto Clear	Auto to clean screen after each display of code reading
Clear	Auto to clean the contents in the display section
EXIT	Exit from the window
Receive Data	Able to operate edit, copy, affix, etc.
Last Mes Len	The length of data message got finally
All Mes Len	Total length of data messages got before
Counts	Count number of data reading in display area at present

2.1.3.2 Update Firmware

Download Setup: Download programs to the device

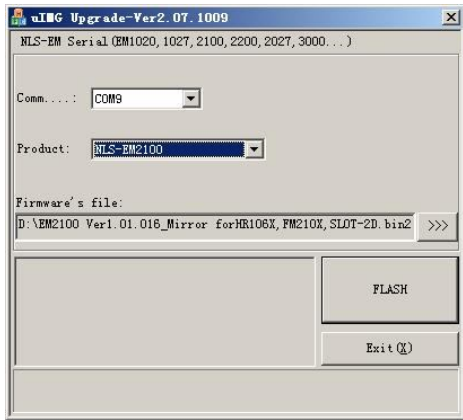
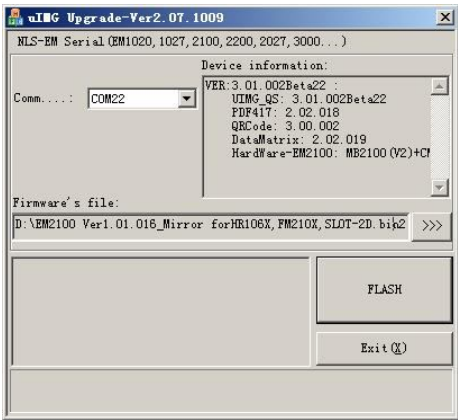
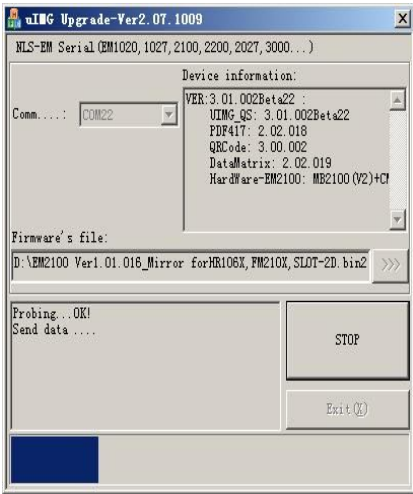
<p>Device is connected</p>  <p style="text-align: center;">(Figure7-1)</p>	<p>Device is unconnected</p>  <p style="text-align: center;">(Figure7-2)</p>
Comm....	Set COM port
Product	Select the device
FLASH	Refresh start button
<p>Open file dialog box , the rate of progress is shown below</p>  <p style="text-align: center;">(Figure7-3)</p>	

2.1.4 Window

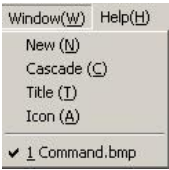
Window		
 <p style="text-align: center;">(Figure 9)</p>	<p>New</p> <hr/> <p>Cascade</p> <hr/> <p>Title Tile</p> <hr/> <p>Icon</p>	<p>Create a new command window</p> <hr/> <p>Cascade</p> <hr/> <p>To arrange icons</p>

2.1.5 Help

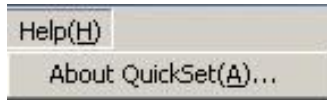

(Figure 10)

“About QuickSet (A)...”: to show the version and registration information of the software (as shown in Figure 11)









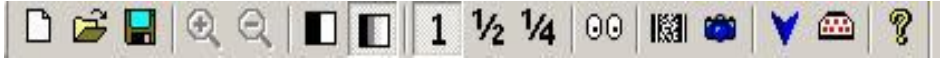









(Figure 11)

2.2 Guide to Toolbar

As shown in Figure 12, Toolbar actually is an easy and swift operation simplified of the menu to enhance speed. Here, we are mainly to point out the function menu corresponding to whose button on the toolbar.



(Figure 12)

	“New”: to create a new command window
	“Open”: to open a new command window or a bitmap
	“Save”: to save currently activated command window or bitmap window
	“Zoom In”: effective only on bitmap displayed, able to magnify the image on the screen and the maximal value is thrice of the original.
	“Zoom Out”: effective only on bitmap displayed, able to dwindle the image on the screen and the minimal value is 1/3 of the original.
	“2 Bit Image”: is “Black and white image” button to transmit binary images
	“8 Bit Image”: is “Gray-level image” button to transmit gray-level images
	“1/1”: transmission of a whole image
	“1/2”: transmission of 1/2 image
	“1/4”: transmission of 1/4 image
	“Auto Detect Baud rate”: to detect the baud rate of device automatically and regulate the communication parameters of host computer
	“Receive Data” is “Real time interception” button: to open real-time interception window and display decoded information (as shown in Figure 6)
	“Capture Image”, that is “Upload image” button: to take pictures and transmit bitmaps to host computer
	“Update Firmware”, that is a “Download program” button: to download programs to device.
	Turn off current the port of COM temporarily, for which is turn-on already.
	“About QuickSet”: to display the version and registration information of the software (as shown in Figure 11)





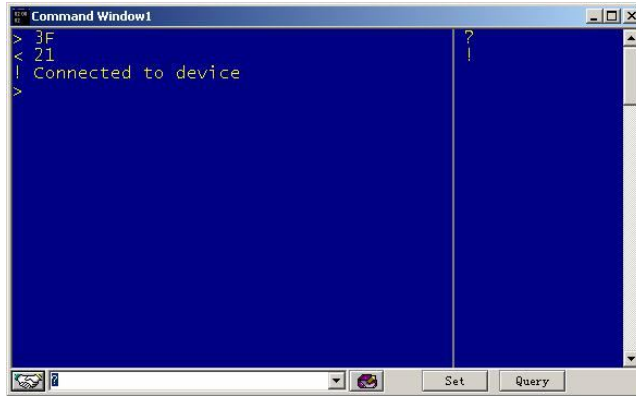

2.3 Guide to Command Window and its Functions

As shown in Figure 13, a command window composed of two parts: command transmission section and outcome display section, is designed to set and read all the parameters of the equipment.



(Figure 13)

2.3.1 Buttons of Command

Command	Functions
	“Handshake order” button: to test if it is in order for communication condition between host computer and the equipments. With a click to the button, the host computer will send a “handshake” order and then wait for response from the equipments. If everything is OK, users will get a normal prompt, otherwise abnormal prompt will occur.
	“Command Edit” box, able to save a list of all commands used so as to make them shortcut when to input same or similar command strings again.
	“Command sending” button: to send any information from the box. An error prompt will show up if a command is sent while nothing to input in the box. <div style="text-align: center;">  <p>(Figure 14)</p> </div>
	“Parameter Setup” button: to pop-up folded menu of setup command
	“Parameter Query” button: to pop up folded menu of query command

2.3.1.1 Parameter Setup

 "Parameter Setup" button: to pop-up folded menu of setup command



(Figure 15-1)

The elaborations of functions for each button on submenu of Set are shown in the following.

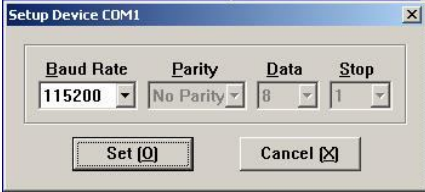
Device COM1	
Set up parameter of communication port of equipment to link, and the setup box will be pop-up after the input of command.	
	
(Figure 16)	
Baud Rate	Speed rate of the communication port, a variable parameter.
The other parameters are forbid	

Light Mode	
Setup parameters of camera lens' flashing, illuminating and aiming lights, and then pop-up of setup box will be shown as below.	
	
(Figure 17)	

CMOS Setup

Setup CMOS parameters, provided only for advanced user, and then pop-up of setup box will be shown as below.



(Figure 18)

Register	It indicates the setup cell of CMOS
Value	The amount of setup

Bar Code Enable ———>> 1D Bar Code Enable

Set up 1D bar code disable and enable, then pop-up of setup box to show.



(Figure 19)

Bar Code Enable ———>> 2D Bar Code Enable

Set up 2D bar code disable and enable, then pop-up of setup box to show.



(Figure 20)

Bar Code Enable —» OCR Enable	
Set up OCR disable and enable, then pop-up of setup box to show.	
	
(Figure 21)	
Ok	Confirm the setup
Cancel	Abort the setup

Bar Code Param —» SetCode	
Set up parameters of SetCode, then pop-up of setup box to show.	
	
(Figure 22)	
Transmit SetCode	Whether to send SetCode after setting-code to read.
Close SetCode	Close SetCode
Open SetCode	Open SetCode

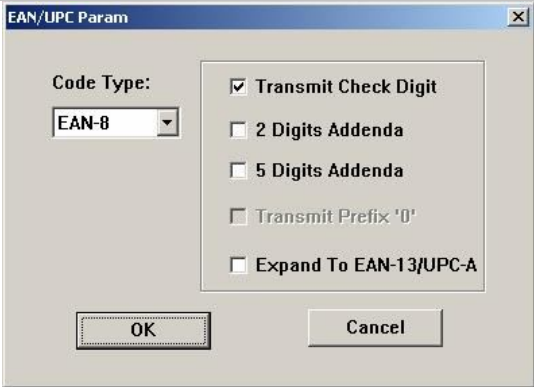
Bar Code Param —» EAN/UPC	
To set up parameters of EAN/UPC	
	
(Figure 23)	
Code Type	Choose the code type need setup
Transmit Check Digit	Whether to transmit Check Digit
2 Digits Addenda	Whether to identify 2 Digits Addenda
5 Digits Addenda	Whether to identify 2 Digits Addenda
Transmit Prefix '0'	Whether to transmit First '0' of UPC-E
Expand To EAN-13/UPC-A	EAN-8 Extend to EAN-13 or UPC-E Extend to UPC-A

Bar Code Param —» Code39/Codabar

To set up parameters of Code39/Codabar

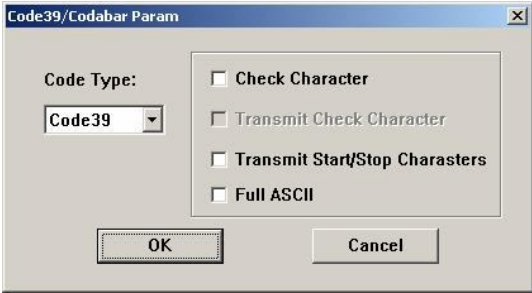

(Figure 24)

Check Character	To Check Character or not
Transmit Check Character	Whether to transmit Check
Transmit Start/Stop Charasters	Whether to transmit Start/Stop Characters
Full ASCII	Whether to identify Full ASCII

Bar Code Param —» I2of5

To set up parameters of Interleaved 2of 5

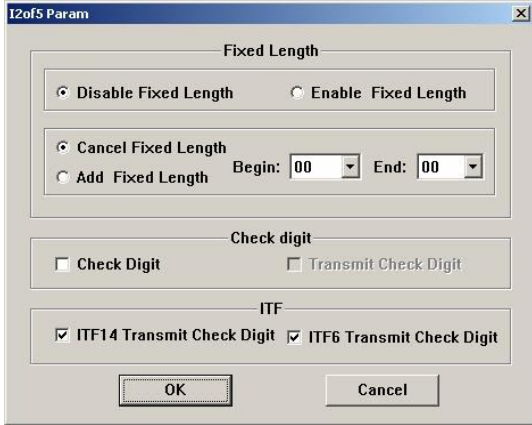

(Figure 25)

Disable Fixed Length	Disable to identify Fixed Length
Enable Fixed Length	Enable to identify Fixed Length
Cancel Fixed Length	Cancel value of Fixed Length
Add Fixed Length	Add value of Fixed Length
Begin	Append the beginning of Fixed Length
End	Append the ending of Fixed Length
Check Digit	Whether to Check Digit
Transmit Check Digit	Whether to send Check Digit if to check
ITF14 Transmit Check Digit	ITF14 to Transmit Check Digit or not
ITF6 Transmit Check Digit	ITF6 to Transmit Check Digit or not

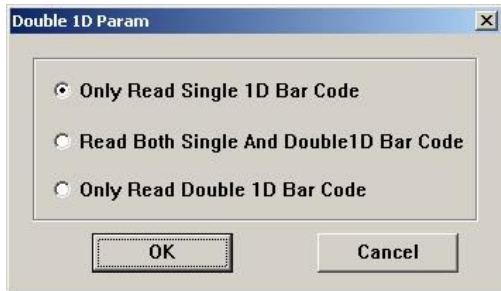
Bar Code Param —» Double 1D Param	
To set up parameters of double 1D	
	
(Figure 26)	
Only Read Single 1D Bar Code	Read Single 1D Bar Code Only
Read Both Single And Double 1D Bar Code	Read Both Single and Double 1D Bar Code
Only Read Double 1D Bar Code	Read Double 1D Bar Code Only

Bar Code Param —» Min/Max Length	
To set up Min/Max Length of code-reading	
	
(Figure 27)	
Code Type	Choose bar code type needed to set up
Min	Set up the min.length of code-reading
Max	Set up the max.length of code-reading

Bar Code Param —» Macro Setup	
To set up decode mode of 2D Macro	
	
(Figure 28)	
No Buff	Send right after scan without any disposal.
Sequence Send	Send data in sequence, with highest store up to 64k bytes.
Sequence Link	Read all symbol, the max. number for the biggest ones is 16, Send right after the link of scan.

Decode Mode—» Scan Mode

To set up scan mode, repetition of code-reading

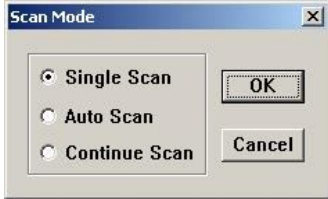

(Figure 29)

Single Scan	Trigger
Auto Scan	Automatic
Continue Scan	Continue

Decode Mode—» Sensibility

To set up sensibility of decode mode

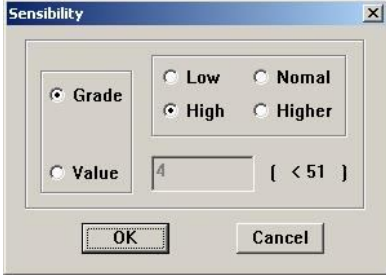

(Figure 30)

Grade (To setup with grade)	Low sensibility
	Normal sensibility
	High sensibility
	Higher sensibility
Value	To set up with value

Decode Mode—» Delay

To set up delay of decode mode, then pop-up of setup box to show.

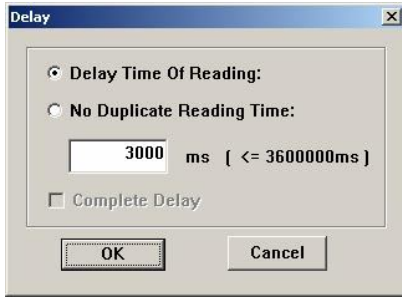

(Figure 31)

Delay Time Of Reading	Delay of Reading a time
No Duplicate Reading Time	No Duplicate Reading Time

Data Format – » Prefix Order

To set up prefix order of data format

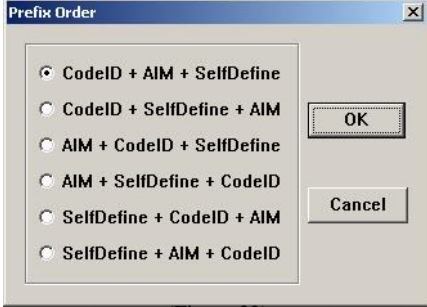

(Figure 32)

Data Format – » Code ID

To set up Code ID of data format



(Figure 33)

Default	Make use of Code ID Prefix of default
User Defined	Make use of self-defined Code ID Prefix
Send ID	Option to send Code ID Prefix or not
Code Type	Option to Code Type needed setting
Code ID	Input Code ID (only valid at User-defined mode)

Data Format – » AIM ID

To set up AIM ID of data format

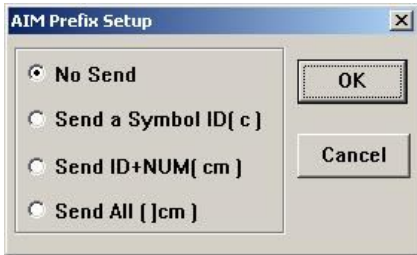

(Figure 34)

No Send	Don't send AIM Prefix
Send a Symbol ID(c)	Send a Symbol of AIM Prefix
Send ID + NUM(cm)	Send two Symbol of AIM Prefix
Send All()cm)	Send all Symbol of AIM Prefix

Data Format —» Pre/Suffix

To set up AIM ID Pre/Suffix of data format

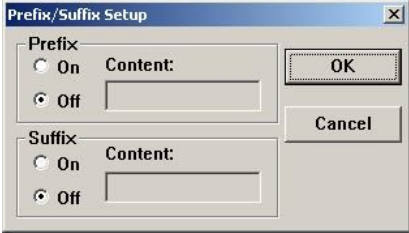

(Figure 35)

On	Turn on the self-defined Pre/Suffix.
Off	Turn off the self-defined Pre/Suffix.
Content	To set up the content of Pre/Suffix, the option is “On”

Data Format —» Terminator

To set up termination of data format

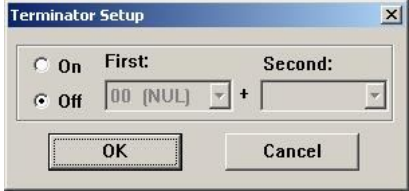

(Figure 36)

On	Send suffix of terminator
Off	Not send suffix of terminator
First	The first character of terminator with an option at On
Second	The second character of terminator with an option at On

Data Format —» Data Packed

To set up data packed of data format

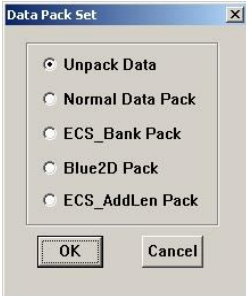

(Figure 37)

Unpack Data	Unpack Data
Normal Data Pack	Normal Data Pack
ESC_Bank	Data Pack with ESC_Bank mode
Blue2D Pack	Data Pack with Blue2D mode
ECS_AddLen	Data Pack with ECS_AddLen mode

Overall—》 Product Param	
To set up product parameters	
	
(如 Figure38)	
Power On Display	Whether to display message when to turn
ESN	To set up ESN Number

Overall—》 Save To User Default	Save current setting as user default
Overall—》 Load User Default	Record user default setting.
Overall—》 Load Factory Default	Factory default setting

2.3.1.2 Parameter Query

 “Parameter Query” button:



- Device COM1
- Light Mode
- Bar Code Enable ▶
- Bar Code Param ▶
- Decode Mode ▶
- Data Format ▶
- Product Param ▶
- Decode Version

(Figure 39-1)



To explain the functions in submenu of Query one by one below with the pop up folded menu of query command:

Device COM1	Query parameters of COM1 port
Light Mode	Query parameters of camera and focus

Bar Code Enable	
Query code's parameters (Enable/Disable)	
	
(Figure 39-2)	
1D Bar Codes Enable	Query enable to current 1D bar code's parameters
2D Bar Codes Enable	Query enable to current 2D bar code's parameters
OCR Enable	Query enable to current OCR type

Bar Code Param	
Each parameter of barcode to query (as shown in Figure 39-3)	
	
(Figure 39-3)	
1D Bar Codes Param	Query of 1D barcode parameter (as shown in Figure 40)  (Figure 40)
Double 1D	Query of double-1D barcode
"Min/Max Length"	Query of maximum and minimum length of code-reading message (as shown in Figure 41)  (Figure 41)
Macro Mode	Query of 2D barcode macro format

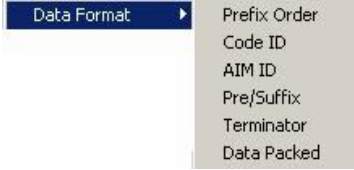
Decode Mode	
Query of decoding format (as shown in Figure 39-4)	
 <p>(Figure 39-4)</p>	
Scan Mode	Scan Mode
Sensibility	Sensibility
Delay Delay	

Data Format	
Query of data format	
 <p>(Figure 39-5)</p> <p>“Code Type”: barcode type set to query</p>	
Prefix Order	Query of prefix order
Code ID	<p>Query of Code Idprefix (as shown in Figure 42)</p>  <p>(Figure 42)</p>
AIM ID	Query of AIM prefix mode
Pre/Suffix	Query of user-defined prefix message
Terminator	Query of terminator suffix
Data Packed	Query of data package way

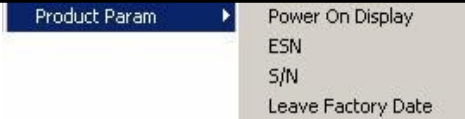
Product Param	
Query of product parameter	
 <p>(Figure 39-6)</p>	
Power On Display	Whether to show query of system message when to turn on the device
ESN”	Query of ESN code
S/N	Query of S/N code
Leave Factory Date	Query of date for product to leave factory

Decoder Version	To inquire about the version information of current decoded program
-----------------	---

2.3.2 Command Display Window

To show the meaning of the following characters:

“>” To show the character string in this line is the command string sent by the host computer.

“<” To show the character string in this line is the command replied from the equipment.

“!” To show the report of outcome upon command completion in this line, or the error prompt.

The display format of character string: every character is displayed in term of ASCII code and is segmented with a blank each other. 16-character a line, in which Chinese characters are included, each Chinese character is composed of two characters, for each character string ended with LRC parity character, and the meaning of each character can be referred to the explanations in the “Command Reference.”

2.4 Guide to Bitmap Window

Bitmap Window is designed to display the bitmap images uploaded from an equipment. A user may judge the operating condition of the camera lens with an analysis on the uploaded images. The interface is as shown in Figure 43.

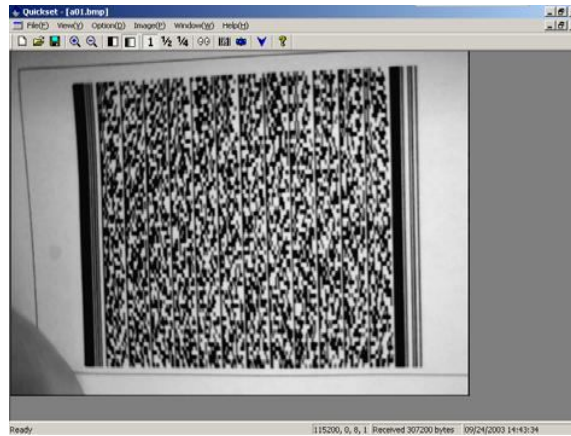

(Figure 43)

The images displayed will be somewhat different and the uploading time will accordingly have some changes when to change the parameters of uploaded images. Users may have a test by themselves, for which we only provide a black and white 2D bitmap in its life size here (as shown in Figure 44)



(Figure 44)

A user may collect several pictures on end, and able to save each one and also to open the saved bitmap pictures too.

Chapter 3 Detailed Command Reference

3.1 Handshake Command

Handshake command—“?”, users only need to input “?” into the command input box and click “Enter”, or just click the handshake command button.

If successful, “!” will be seen in the command display window;

If failed, “No Answer” otherwise will occur.

3.2 Setup Command

Description: parameters setup command, sent by host equipments.

Form of setup command: command style (single character) +setup parameter sequence (10 characters)

Symbol of command style: “1” (0x31)

Pattern to setup parameter sequence:

Length: 10 Bytes

Pattern:

1-2: Master Properties	3: Secondary Properties	4-10: Parameter
------------------------	-------------------------	-----------------

Master Properties:

3.2.1 ‘00’: communication parameter setup

Secondary Properties:

‘0’——COM1 parameter setup

‘1’——COM2 parameter setup

Parameter:

Byte 4-5 corresponds to bit 0-3 of “communication return parameter”, denoted by ASCII of decimal system;

Byte 6 corresponds to bit 4-5 of “communication return parameter”, denoted by ASCII of decimal system;

Byte 7 corresponds to bit 6 of “communication return parameter”, denoted by ASCII of decimal system;

Byte 8 corresponds to bit 7-8 of “communication return parameter”, denoted by ASCII of decimal system;

Byte 9-10 preserved, default set is “0”.

For example:

To set COM1 parameters as follows: Baud Rate-15200, 8 data bits, 1 stop bit and non parity bit, the parameter sequence should be “00-0-11-0-0-3-00”.

3.2.2 ‘01’: Reserved (CMOS parameter quondam)

3.2.3 ‘02’: Light and aiming setup

Secondary Properties: Ignored

Parameter:

Byte 4 corresponds to bit 0-1 of “light/aiming return parameter”, aiming mode, denoted by ASCII of decimal

system;

Byte 5 corresponds to bit 2-3 of “light/aiming return parameter”, light mode, denoted by ASCII of decimal system;

Byte 6-10 preserved, default set is “0”.

For example:

Set light and aiming to standard mode, the command sequence should be “02-0-0-0-0000”.

3.2.4 ‘03’: 1D barcode setup

Secondary Properties:

‘0’——disable

‘1’——enable

Parameter:

Byte 4-5 corresponds to bit 0-31 of “one-dimensional return parameter”, Denoted by ASCII of decimal system;

Byte 6-10 preserved, default set is “0”.

For example:

To prohibit reading EAN-13 bar code, the command sequence should be “03-0-05-0000”.

3.2.5 ‘04’: 2D barcode reading setup

Secondary Properties:

‘0’——disable

‘1’——enable

Parameter:

Byte 4-5 corresponds to bit 0-31 of “one-dimensional return parameter”, denoted by ASCII of decimal system;

Byte 6-10 preserved, default set is “0”.

For example:

To permit reading QR code, the command sequence should be ‘04-1-01-0000’.

3.2.6 ‘05’: Code reading overall setup

Secondary Properties:

‘0’——disable reading all one-dimensional and planar codes;

‘1’——enable reading all supported one-dimensional and planar codes;

Parameter:

Byte 4-10 preserved, default set is “0”.

3.2.7 ‘06’: Macro mode setup

Secondary Properties:

‘0’ —— Macro mode setup

‘1’ —— Macro identifier setup

Parameter:

Byte 4-5: Corresponds to the barcode place in the Macro Map

Byte 6-10: Reserved, default is ‘0’

For example 1:

Setup: Transmit right after scan

Command sequence: 06 - 0 - 01 – 00000

For example 2:

Setup:Transmit according to code sequence, the memory buffer is 64kbyte

Command sequence: 06 - 0 - 02 - 00000

For example 3:

Setup:Read all bar codes in memory buffer, and then send out at once.

Command sequence: 06 - 0 - 03 - 00000

3.2.8 '07': Initialized

Secondary Properties: ignore

Parameter:

Byte3~4:

'00': Set all to factory Default

'01': Save current to user default

'02': load user default

Byte5-10: Reserved, default is '0'

3.2.9 '08': 2D barcode reading combined setup(enable/disable)

Secondary Properties:

'0'——disable, this command means “and” with original parameters;

'1'——enable, this command means “or” with original parameters.

Parameter:

Byte4:

'0'——operation of low 16-bit parameters;

'1'——operation of high 16-bit parameters;

Byte5-10: 16-bit parameter denoted by decimal system.

For example:

To simultaneously enable PDF417 and QR Code

The command should be 08-1-0-000003.

3.2.10 '09': 1D barcode reading combined setup (enable/disable)

Secondary Properties:

'0'——disable, this command means “and” with original parameters;

'1'——enable, this command means “or” with original parameters.

Parameter:

Byte4:

'0'——operation of low 16-bit parameters;

'1'——operation of high 16-bit parameters;

Byte5-10: 16-bit parameter denoted by decimal system.

For example: to simultaneously enable EAN-13 and Code128, the command should be 09-1-0-000036.

3.2.11 '10': Barcode length setup

Secondary Properties: Barcode type

Byte3~4: '00'~'99'

Parameter:

Byte5~8: 0001~ffff —— barcode max length

Byte9~12: 0001~ffff —— barcode min length

3.2.12 '11': 1D barcode parameters setup

Secondary Properties: Corresponds to the position of Code 1D Bit Map

Byte3~4:

- '00': Setting code setup
 - Byte8: (bit 1) Transmit Setting Code setup
 - '0' —— Don't Transmit Setting Code when reading it **
 - '1' —— Transmit Setting Code when reading it *
 - Byte8: (bit 2) Turn on or turn off the setting code setup
 - '0' —— Turn off **
 - '1' —— Turn on
- '02': Code 128 parameter setup
 - Byte5: Corresponds to bit 15-12 of "code128 parameter", denoted by ASCII of decimal system;
 - Byte6: Corresponds to bit 11-8 of "code128 parameter", denoted by ASCII of decimal system;
 - Byte7: Corresponds to bit 7-4 of "code128 parameter", denoted by ASCII of decimal system;
 - Byte8: Corresponds to bit 3-0 of "code128 parameter", denoted by ASCII of decimal system;
- '04': EAN-8 parameter setup
 - Byte7: Corresponds to bit 7-4 of "EAN/UPC parameter", denoted by ASCII of decimal system;
 - Byte8: Corresponds to bit 3-0 of "EAN/UPC parameter", denoted by ASCII of decimal system;
- '05': EAN-13 parameter setup
 - Byte7: Corresponds to bit 15-12 of "EAN/UPC parameter", denoted by ASCII of decimal system;
 - Byte8: Corresponds to bit 11-8 of "EAN/UPC parameter", denoted by ASCII of decimal system;
- '06': UPC-E parameter setup
 - Byte7: Corresponds to bit 23-20 of "EAN/UPC parameter", denoted by ASCII of decimal system;
 - Byte8: Corresponds to bit 19-16 of "EAN/UPC parameter", denoted by ASCII of decimal system;
- '07': UPC-A parameter setup
 - Byte7: Corresponds to bit 31-28 of "EAN/UPC parameter", denoted by ASCII of decimal system;
 - Byte8: Corresponds to bit 27-24 of "EAN/UPC parameter", denoted by ASCII of decimal system;
- '08': I2of5 parameter setup
 - Byte5: Corresponds to bit 15-12 of "I2of5 parameter", denoted by ASCII of decimal system;
 - Byte6: Corresponds to bit 11-8 of "I2of5 parameter", denoted by ASCII of decimal system;
 - Byte7: Corresponds to bit 7-4 of "I2of5 parameter", denoted by ASCII of decimal system;
 - Byte8: Corresponds to bit 3-0 of "I2of5 parameter", denoted by ASCII of decimal system;
 - Byte9:
 - '0' —— Cancel fixed length
 - '1' —— Add fixed length
 - Byte10: The high bit of the start vaule for add/cancel fixed length (denoted by hex)
 - Byte11: The low bit of the start vaule for add/cancel fixed length (denoted by hex)
 - Byte12: The high bit of the end vaule for add/cancel fixed length (denoted by hex)
 - Byte13: The low bit of the end vaule for add/cancel fixed length (denoted by hex)
- '13': Code 39 parameter setup
 - Byte5: Corresponds to bit 15-12 of "code39 parameter", denoted by ASCII of decimal system;

Byte6: Corresponds to bit11-8 of “code39 parameter”, denoted by ASCII of decimal system;
 Byte7: Corresponds to bit 7-4 of “code39 parameter”, denoted by ASCII of decimal system;
 Byte8: Corresponds to bit 3-0 of “code39 parameter”, denoted by ASCII of decimal system;

□ ‘15’: Codabar parameter setup

Byte5: Corresponds to bit 15-12 of “codabar parameter”, denoted by ASCII of decimal system;
 Byte6: Corresponds to bit 11-8 of “codabar parameter”, denoted by ASCII of decimal system;
 Byte7: Corresponds to bit 7-4 of “codabar parameter”, denoted by ASCII of decimal system;
 Byte8: Corresponds to bit 3-0 of “codabar parameter”, denoted by ASCII of decimal system;

3.2.13 ‘12’: Decoding mode setup

Secondary Properties:

Byte3~4:

□ ‘00’: scan mode setup

Byte5:

‘0’— Trigger
 ‘1’— Auto Scan
 ‘2’— Continue Scan

□ ‘02’: CMOS Sensibility setup

Byte5:

‘0’— level setup

Byte6:

‘0’— Low
 ‘1’— Normal
 ‘2’— High
 ‘3’— Higher
 ‘4’— Set value of sensitivity

‘1’— Set value of sensitivity

Byte6~7: Set vaule which denoted by decimal system(Max: 20)

□ ‘03’: delay time setup

Byte5:

‘0’— Delay Time of Each Reading setup

Byte6: Reserved

Byte7~13: Delaytime, denoted by decimal system(Unit : ms)

‘1’— No Duplicate Reading setup

Byte6:

‘0’— incompletely delay
 ‘1’— completely delay

Byte7~13: Delaytime, denoted by decimal system(Unit : ms)

3.2.14 ‘13’: System overall setup

Secondary Properties:

Byte3~4:

□ ‘00’: Send message related to system setup

Byte5:

‘0’— don’t display when power on **

- ‘1’—— display when power on
- ‘01’: Double-1D setup
 - Byte5:
 - ‘0’—— 1D Bar Codes only read one code *
 - ‘1’—— 1D Bar Codes read the one or two codes(the same type)
 - ‘2’—— 1D Bar Codes only read two codes(the same type)
- ‘02’: product ESN setup(Max: 20 Bytes)
 - Byte5~6: length of ESN, denoted by decimal system
 - Byte7~: ESN information

3.2.15 ‘14’: reserved

3.2.16 ‘15’: data format setup except prefix/suffix

Secondary Properties:

Byte3~4:

- ‘00’: Data packaged setup
 - Byte5~6:
 - ‘00’—— Unpackaged
 - ‘01’—— Normal Packaged
 - ‘02’—— ECS_Bank Packaged
 - ‘03’—— Blue2D Packaged
 - ‘04’—— ECS_AddLen Packaged

3.2.17 ‘16’: OCR enable/disable setup

Secondary Properties:

- ‘0’—— disable
- ‘1’—— enable

Parameter:

Byte4:

- ‘0’—— operate low 16 bit Parameters
 - ‘1’—— operate high 16 bit Parameters
- Byte5-10: 16 bit Parameters, denoted by decimal system

For example

Setup: Disable SPEC_OCR_B

Command sequence: 16-1-0-000001

3.2.18 ‘17’: Reserved

3.2.19 ‘18’-‘25’: Reserved

3.2.20 ‘26’: Repeat rading and delay reading setup

Secondary Properties:

- ‘0’—— Disable
- ‘1’—— Enable

Parameter:

Byte4:

‘0’—— operate low 16 bit Parameters

‘1’—— operate high 16 bit Parameters

Byte5:

‘0’—— single operate: LED always on when reading

‘1’—— Delay time setup, as below

‘2’—— the closing time of LED when without barcode was reading (under continue read mode)

‘3’——LED setup: ON / Flash

‘4’ ~ ‘9’—— reserved

Byte6-10: 16 bit Parameters, denoted by decimal system

For example 1:

Setup: LED always on

Command sequence: 26-1-0-0-00004

For example 2:

Setup: LED delay time (1000ms)

Command sequence: 26-1-0-1-01000

3.2.21 ‘27’: self-prefix/ self-suffix setup

Secondary Properties

- ‘0’—— self-prefix setup, single setup
- ‘1’—— self-prefix setup, single setup
- ‘2’——Self- terminator-suffix setup, single setup

Parameter:

Byte4~5: length of self-prefix/ self-suffix

Byte6~7: the location of Current settings information

Byte8~10: settings information, denoted by ASCII of HEX

For example:

Setup: the barcode prefix is ‘EAN’:

Command sequence:

1+27+0+03+00+045

1+27+0+03+01+041

1+27+0+03+02+04E

- ‘3’—— user define CodeID setup(only one)

Parameter:

Byte4: transmit Code ID setup, 0---transmit,1----Don’t transmit

Byte5: 0----default CodeID, 1---- user define CodeID

Byte6~7: Code Type, 0~31for 1D, 32~63 for 2D, 64 for SPEC_OCR_B

Byte8: setting information

- ‘4’—— batch prefix/suffix setup (don’t according to fixed length of protocol)

Parameter:

Enable prefix (1Byte: 0,1)

+ prefix length setup (2Byte: 00~10)
 +prefix information (0~10Byte)
 +enable suffix (1Byte: 0,1)
 + suffix length setup (2Byte: 00~10)
 +suffix information (0~10Byte)

For example:

Setup: prefix is "NLS", suffix is "ZA"

Command sequence: 1+27+4+03+'NLS'+02+ 'ZA'

- '5'—— batch Stop Charasters setup (don't according to fixed length of protocol)

Parameter:

Transmit Stop Charasters (1Byte: 0,1)
 + setting information length (1Byte: 1,2,3)
 +prefix information(0~2Byte)

For example:

Setup: Stop Charasters----"CR+LF"

Command sequence: 1+27+5+1+2+0D+0A

- '6'—— AIM ID setup

Parameter:

Mark (1Byte: 0, 1 , 2, 3)

0 ----- disable AIM ID
 1 ----- Only Enable One Character: c
 2 ----- Only Enable Two Characters AIM ID: c+m
 3 ----- Enable All :] + c +m

- '7'—— prefix order setup (don't according to fixed length of protocol)

Parameter:

Byte4:

'0'—— CodeID+AIM+self-prefix **
 '1'—— CodeID+self-prefix+AIM
 '2'—— AIM+ CodeID+self-prefix
 '3'—— AIM+self-prefix+ CodeID
 '4'—— self-prefix+CodeID+AIM
 '5'—— self-prefix+AIM+CodeID

For example:

Setup: set the prefix order : AIM+ CodeID+self-prefix

Command sequence: 1+27+7+2+000000

3.2.22 '28': prefix/suffix setup

Secondary Properties:

'0'—— disable
 '1'——enable

Parameter:

Byte4~5: type of prefix/suffix

'00'—— All Prefix and Suffix
 '01'—— self-prefix

- '02'—— self-suffix
- '03'—— CodeID
- '04'—— AIM
- '05'—— terminator suffix

3.2.23 '29'-'99': reserved

3.3 Setup Return

Description: parameter setup responds from equipments.

Form of setup return: command style(1 character)+returned parameter(1 character)

Symbol of command style: '2' (0x32)

Returned parameters:

- '0'——setup successful;
- '1' ——setup failed.

3.4 Inquir Command

Description: parameter inquiring command, sent by host equipments.

Form of inquiry command: command style(1 character)+inquiry parameter(1 character)

Symbol of command style: '3' (0x33)

Inquiry parameters:

3.4.1 0x30、0x31——to inquire parameter of communication

3.4.2 0x32——to inquire 1D bar code permit or prohibit

3.4.3 0x33——to inquire 2D bar code permit or prohibit

3.4.4 0x34——reserved (to inquire preferential reading parameter)

3.4.5 0x35——to inquire light/aiming setup parameter;

3.4.6 0x36——to inquire macro setup

3.4.7 0x37——to inquire prefix/suffix

3.4.8 0x38——to inquire CodeID

Byte2~3: type of barcode,

1D: 0~31, 2D: 32~64, OCR: 64~96

3.4.9 0x39——to inquire AIM

3.4.10 0x40——to inquire terminator suffix

3.4.11 0x41——to inquire minimum length and maximum length

Byte2~3: type of barcode,

1D: 0~31, 2D: 32~64, OCR: 64~96

3.4.12 0x42——to inquire prefix/suffix order

3.4.13 0x43——to inquire 1D barcode parameter

Byte2~3: type of barcode,

These 1D barcode can be inquire : ZASETUP、Code128、EAN-8、EAN-13、UPC-E、UPC-A、I2of5、Code 39、Codabar.

3.4.14 0x44—to inquire decode mode

Byte2~3:

- '00'—— to inquire scan mode
- '01'—— to inquire image sieve
- '02'—— to inquire cmos Sensibility
- '03'—— to inquire delay time

Byte4:

- '0'—— Delay Time of Each Reading setup
- '1'—— No Duplicate Reading
- '04'—— to inquire the limitd times of decoding

3.4.15 0x45—Reserved**3.4.16 0x46—to inquire the data format except prefix/suffix**

Byte2~3: '00'——to inquire data packaged

3.4.17 0x47—to inquire version**3.4.18 0x48—to inquire overall information**

Byte2~3:

- '00'—— to inquire if display system information or not when power on
- '01'——to inquire double-1D decoding mode
- '02'—— to inquire ESN
- '03'—— to inquire S/N
- '04'—— to inquire the date of the product leave factory

3.4.19 0x49—to inquire OCR disable/enable**3.4.20 0x4A—to inquire user especial Parameter**

Byte2~3:

- '00' the first especial user

Byte4:

- '0'—— to inquire information send type
- '1'—— to inquire head information
- '2'—— to inquire secret key information
- '3'—— to inquire 4 especial Parameters

3.4.21 0x4B~0xFF—Reserved**3.5 The return of inquire command**

Description: parameter inquiry results, sent from equipments.

Form of inquiry return: command style (1 character) +returned parameter (4 characters)

Symbol of command style: '4' (0x34)

Pattern to return parameters are as follows:

STX+ATTR+LENS(2Bytes)+AL_SET_Q_ECHO+DATA+LRC

Length: 4 Bytes

Pattern: separated into the following because of different inquiry command

3.5.1 To inquire parameter of communication

DATA: Com Param (4 bytes)

3.5.2 To inquire 1D bar code disable or enable

DATA: Code 1D BitMap (4 bytes)

3.5.3 To inquire 1D bar code disable or enable(reserved)

DATA: Code 2D BitMap (4 bytes)

3.5.4 To inquire light/aiming

DATA: Light Param (4 bytes)

3.5.5 To inquire macro setup

DATA: 0x00 + 0x00 + 0x00 + macro mode

Macro mode:

0x30 ——Transmit right after scan

0x31 ——Transmit according to code sequence, the memory buffer is 64kbyte

0x32 ——Read all bar codes in memory buffer, and then send out at once.

3.5.6 To inquire self-prefix/ self-suffix

DATA:

prefix disable/enable+ prefix length + prefix + suffix disable/enable+ suffix length + prefix

1byte: 0/ 1

1byte

1byte: 0/ 1

1byte

3.5.7 To inquire CodeID

DATA: disable/enable + barcode type + Code ID

1byte: 0/1

2bytes

1byte

3.5.8 To inquire AIM

DATA: mode Number

0 ---- disable AIM ID

1 ----- Only Enable One Character: c

2 ----- Only Enable Two Characters AIM ID: c+m

3 ----- Enable All:] + c +m

3.5.9 To inquire terminal suffix

DATA: disable/enable + terminal suffix length + terminal suffix

0x30/0x31

1bytes

3.5.10 To inquire minimum length and maximum length

DATA: 10-digit of barcode type + 1-digit of barcode type + max length + min length

0x30~0x39

0x30~0x39

4bytes

4bytes

3.5.11 To inquire Prefix order

DATA: type number (0x30 ~ 0x35)
 0x30—— CodeID+AIM+self-prefix **
 0x31—— CodeID+self-prefix+AIM
 0x32—— AIM+ CodeID+self-prefix
 0x33—— AIM+self-prefix+ CodeID
 0x34—— self-prefix+CodeID+AIM
 0x35—— self-prefix+AIM+CodeID

3.5.12 To inquire 1D barcode Parameters

DATA:
 ZASETUP: 0x30 + 0x30 + 0x00 + 0x00 + 0x00 +Parameter
 Parameter: bit 0---setting code information sent or not
 bit1-----turn on/off setting code
 CODE128: 0x30 + 0x32 + BitMap
 EAN8: 0x30 + 0x34 + BitMap
 EAN13: 0x30 + 0x35 + BitMap
 UPCE: 0x30 + 0x36 + BitMap
 UPCA: 0x30 + 0x37 + BitMap
 INTERLEAVED 2 OF 5: 0x30 + 0x38 + BitMap + Fixed Len (the information of 32 fixed length)
 MATRIX25: 0x31 + 0x31 + BitMap
 CODE39: 0x31 + 0x33 + BitMap
 CODABAR: 0x31 + 0x35 + BitMap

Note: BitMap length are 4bytes, corresponding to Parameter of barcode, paragraph per 4 bits, every value change to hex characters then

3.5.13 To inquire decoding mode

DATA:
 Scan mode: 0x30 + 0x30 + mode Parameter
 Mode Parameter:
 0x30: 1D Bar Codes only read one code
 0x31: 1D Bar Codes read the one or two codes
 0x32: 1D Bar Codes only read two codes

 Image sieve:
 0x30 + 0x31 + disbale/enable (0x30/0x31)
 Sensibility:
 0x30 + 0x32 + 0x31 + $\frac{10\text{-digit of sensibility}}{0x30\sim 0x39}$ + $\frac{1\text{-digit of sensibility}}{0x30\sim 0x39}$

 Delay Time Of Reading
 0x30 + 0x33 + 0x30 + 0x30 + deley value
 7bytes: 0~3600000

No Duplicate Reading Time

0x30 + 0x33 + 0x31 + disable/enable + deley value
 0x30/0x31 7bytes: 0~3600000

The limitid times of decoding

0x30 + 0x34 + limitid times (5bytes: 0~65535)

3.5.14 To inquire the data format except prefix/suffix

DATA:

data packged: 0x30 + 0x30 + 打包 ▪ 型

Packged type: 0x30 + 0x30 —— dispackged
 0x30 + 0x31 —— normal packaged
 0x30 + 0x32 —— ECS_Bank packaged
 0x30 + 0x33 —— Blue2D packaged
 0x30 + 0x34 —— ECS_AddLen packaged

3.5.15 To inquire version

Sent format: 0x7E+0x00+0x00+0x02+0x33+0x47+0x89

Return format: 0x02+0x00+ lens (2bytes) +0x34+DATA+LRC

(Len(s) high 8 bits) *10 + Len(s)low 8 bits= DATAlength +1(the byte of “0x34”)

DATA:

VER: X.XX.XXX[blank]XXXXXX: [blank]XXXXXX+XXXXXX

3.5.16 To inquire overall infromation

DATA:

Display system information or not when power on: 0x30 + 0x30 + disable/enable0x30/0x31)

Double-1D decoding mode: 0x30 + 0x31 + double-1D setting mode

Double-1D setting mode:

0x30 ——1D Bar Codes only read one code
 0x31 ——1D Bar Codes read the one or two codes
 0x32 ——1D Bar Codes only read two codes

To inquire ESN :

0x30+0x32+10-digit of ESN length+ 1-bit of ESN length +ESN
 0x30~0x39 0x30~0x39

To inquire S/N :

0x30+0x33+ 10-digit of S/N length+ 1-bit of S/N length+ S/N
 0x30~0x39 0x30~0x39

To inquirethe date of product leave factory

0x30+0x34+ 10-bit of date length+1-bit of date length +date
 0x30~0x39 0x30~0x39

3.5.17 To inquire OCR disable/enable

DATA: OCR BitMap (4bytes)

3.5.18 To inquire user especial Parameter

DATA:

The first especial user:

To inquire information sends type:

0x30 + information sends type (+compart character length + compart character)
 0x30~0x39 '00'~'15'

To inquire head information:

0x31 + group number + head information length + head information
 '00'~'09' '00'~'32'

to inquire secret key information:

0x32 + group number + secret key length + secret key information
 '00'~'09' '00'~'32'

to inquire 4 especial Parameters

0x33 + group number + INFO_F1 + INFO_F2 + EKEY_F1 + EKEY_F2
 '00'~'09' 1 Byte 1 Byte 1Byte 1 Byte

3.6 Format of inquire return

3.6.1 Communication return formate



Bit 0-3: baud rate

0000:	1200
0001:	2400
0010:	4800
0011:	9600
0100:	14400
0101:	19200
0110:	38400
0111:	57600
1000:	115200
1001...1111:	Reserved

Bit 4-5: verify

00:	None
01:	even
10:	odd

Bit 6: stop bits

0:	1
1:	2

Bit 7-8: data bits

00:	5
01:	6
10:	7
11:	8

Bit 9-30: reserved

Bit 31: communication port

0:	COM1
1:	COM2

3.6.2 1D barcode Parameter

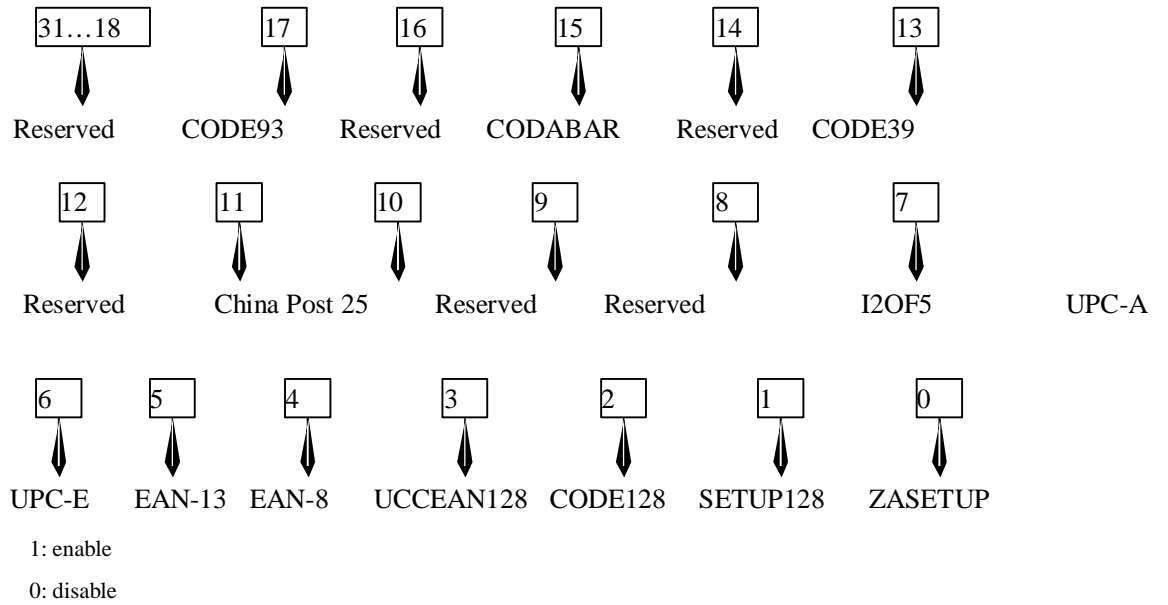

3.6.3 2D barcode Parameter

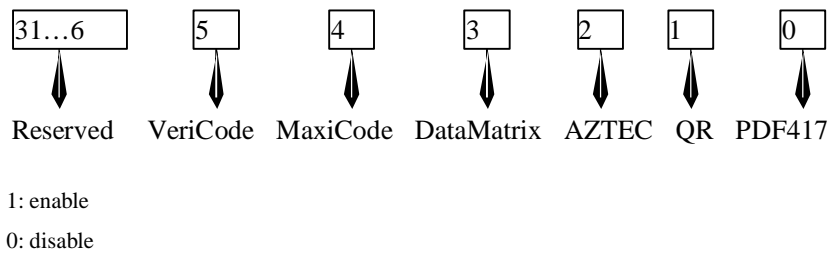

3.6.4 OCR Parameter

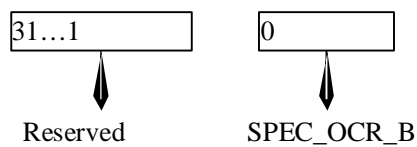

3.6.5 Light 、 aiming Parameter

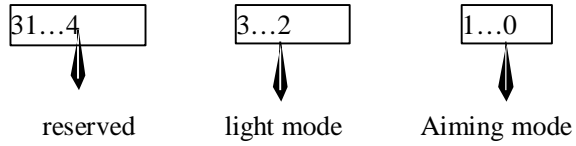

Light mode:

- 00 : General aiming mode, the aiming lights when the scan trigger is pressed
- 01 : LED Always On
- 10 : LED Always Off
- 11 : Reserved

Aiming mode:

- 00 : General light mode, only light when read the CMOS data
- 01 : LED Always On
- 10 : LED Always Off
- 11——reserved

Chapter 4 Guide to operations in common use

1、 How to carry out equipment-detecting

System will be detected thoroughly for the connected equipment automatically once a user starts to run QuickSet.

In the process of operation, it is necessary for the user to examine the device when unable to communicate with the equipment. Click “Auto Detect” in the toolbar to adjust the baud rate of communication to the equipment.

“Connect to COM1” or “Connect to COM2”, as well as the baud rate of communication with the equipment, will be shown in the status bar when to detect the device; if unable to detect the equipment, “Connect COMX fail!” will be displayed on the status bar to remind the user of something error, with this, a user may check whether the communication port or connecting cable between the computer and the device is linked incorrectly, if the failure is found, change communication port and make the equipment detecting again.

2、 How to change baud rate of communication

In the process of the equipment in use, users often need to change the baud rate of communication to the equipments, in order to adapt the current usage of device better and better. Under normal condition of communication, users may improve the response speed of the equipments with the increase in the baud rate of communication, or to reduce the BER of communication with the decrease in the baud rate of communication.

It is able to adjust the baud rate of communication to 115200bps when a user to upload an image, for which is able to improve the communication speed and shorten the uploading time.

Methods to change: first to confirm the communication port of device, this is COM1 generally. Under the condition able to guarantee the normal communication with the device, click “Set” menu “COM Port” “Setup Device COM1” till to choose the baud rate adjusted in advance in the pop-up dialogue box and click “Yes” to make a confirm. All of these are done the success configuration parameters will be shown up in the command window; otherwise, the error prompt will appear too.

3、 How to display decoded information

With decoding, any information read by equipment will be sent to the host computer, in order to let a user examine or look over the message searched.

To click the button of “Data” on the toolbar, the display box for decoded information will be brought to the screen. Under the normal communication between the host computer and the equipment, the decoded information will be displayed in the decoded information box in the form of character or ASCII code and can be easy for the user to read.

4、 How to upload images

Images-uploaded is useful for a user to check the shooting function of a equipment easily and to definite whether a picture taken is in focus.

There are a lot of ways to upload, such as with 2 bit or 8 bit to upload images in a variety of proportion.

Under the condition for the uploading way chosen and the normal communication guaranteed, it is available for a user to adjust position for the equipment (such as to focus the camera lens on the objective and peg the distance between the goal and camera), and click "Capture Image" button on the toolbar. In the normal condition to accept, the received bytes on the toolbar will continually increase, for which needs the user to wait a while to complete the task of upload; otherwise, the received bytes will never change. In an error case, the user may turn off the window of images and to renew the receiving program.

It is able to adjust the baud rate of communication to 115200bps when a user to upload an image, for which is able to improve the communication speed and shorten the uploading time.

5、 How to send commands with serial port

In some applications, users may try to command scanner as they want, such as to start up device, read Modes, turn off LED flashing automatically after one reading, or let the device be a standby with a state of LED ON or LED OFF.

In the list of QuickSet commands, it is able for us to drive device with the way of command-combination as shown below:

"ESC + 0" – LED OFF, Stop to scan

"ESC +1" – Setting to read bar code once, it will turn off LED if reading success; or it is going to turn off with a last for 120 seconds if it does never read any code.

"ESC + 2" – LED ON, to keep on a status of scanning.

"ESC + 4" – The command of setup to read paper bar codes only

"ESC + 5" – The command of setup to read cell phone bar codes only

"ESC + 6" – Set to return factory defaults (and can read paper & cell phone bar code)

For the command line box in QuickSet, only visible characters are accepted. So it is necessary to make use of two characters in 0~9, A~F or a~f as Hex character right after an escape character begun with '\'.

Example 1:

Since the value of ESC in ASCII is 0x1b, of which, the value of '1' in ASCII is 0x31, but '1' is a visible character however, it is able to write a command in the line with the way of '\!1b1' and send the message to COM port, equivalent to ESC+1.

Example 2:

If to control with program, for example, assume to send ESC+2:

```
char buff[3];
```

```
buff[0] = 0x 1b; buff[1] = 0x32; buff[3] = 0;
```

as long as to send buff character string to COM, that's it, with a length of 2.